

Alarm	Display	Relay	Actions to do
Level	Level___7,2_ph	Alarm Relay Close	- Push Enter Key to open Alarm Relay - Restore Product tank
OFA First Alarm (time >70%)	OFA_Alarm__7,2_ph	Alarm Relay open	- Push Enter Key to reset
OFA Second Alarm (time =100%)	OFA_STOP__7,2_ph	Alarm Relay Close	- Push Enter Key to reset
Flow Rate	Flow_____7,2_ph	Alarm Relay open	- Restore Flow Rate
System Error	Parameter_Error	Alarm Relay Open	- Press Enter Key to replace Default parameter - Destroy Unit
Calibration Funciont	Error_7_ph Error_4_ph Error_465_mV	Alarm Relay open	- Restore Probe or Buffer solution and repeat calibration function

- Default parameters:**
- Language = **FR (French)**
 - Set Point value= **7,2 pH; 750mV (Rx)**
 - Dosing Method = **Acid; Low (Rx)**
 - Time OFA = **OFF**
 - Calibration = **7/4 (2 point); 465mV (Rx)**
 - Flow Input= **ON**

- To restore Default parameters run Following steps:**
- Power off Pool Basic unit
 - Keeping Press UP and DOWN Key switch on the Power.
 - The unit will flash **Init.default__no**
 - Press up **Init.default__Yes**
 - Enter Key to restore Default parameters.

LMP

Verpackungsinhalt

- A) "LMP" pH/Redox Steuereinheit (Standardmodell)
- B) PVC Ansaugschlauch Crystal 4x6 (4 m)
- C) Polyethylen Druckschlauch (5 m)
- D) Schraubendübeln ($\phi = 6$ mm)
- E) Fußfilter (PVC)
- F) Rückschlagventil aus FPM (3/8" GAS)
- G) SPH-1 pH-Elektrode
- H) PSS3 Sondenhalter (1/2" GAS)
- I) Montagebügel für PSS3 2" ($\phi=50$ mm)
- L) pH 4, pH 7, H₂O Kit Pufferlösung
- M) Reduzierstück für Rückschlagventil

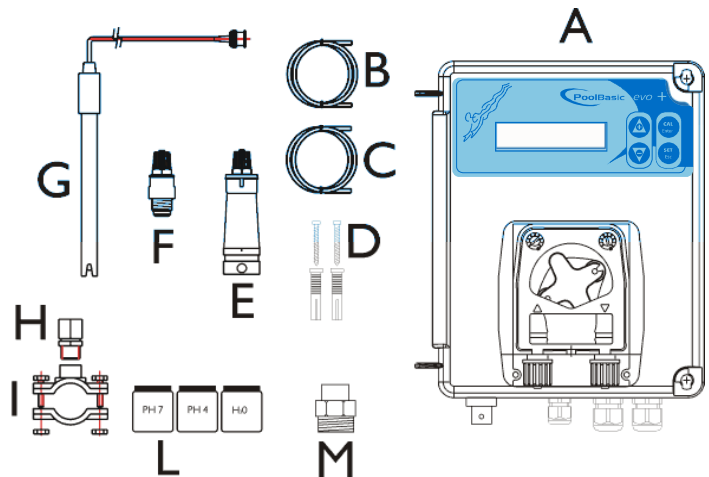

TECHNISCHE DATEN

Abmessungen (H - B - T)	234x162x108 mm
Gewicht	1 kg
Spannungsversorgung	230 Vac
Verbrauch	12 W oder 18 W
Förderleistung der Pumpe	1,5 l/Std.
Max. Gegendruck	1,5 bar
Pumpenstatus	Pause - Betrieb
Messskala	pH 0 ÷ 14.0; Redox 0 ÷ +1000mV
Messgenauigkeit	± 0,1 pH; ±10 mV
Genauigkeit Maß	± 0,02 pH; ±2 mV
Kalibrierung der Elektrode	automatisch

Wandmontage

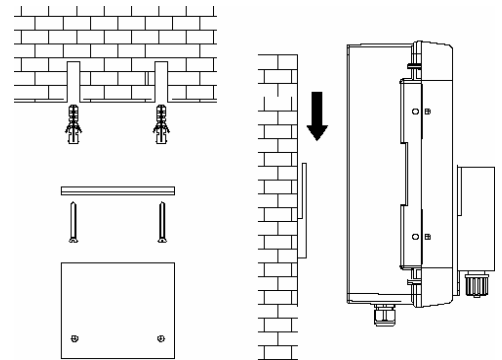

ATTENZIONE / WARNING / ATTENTION / ACHTUNG

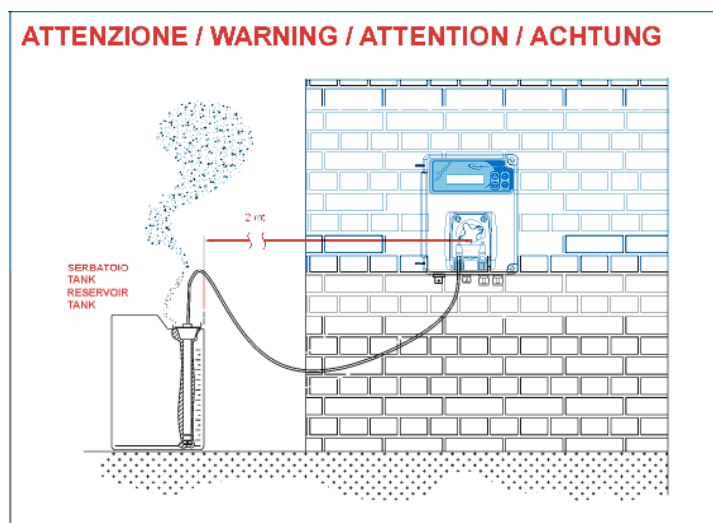



Einstellungen

Funktion:



- **Kalibrierung**

- 3 Sekunden lang die Taste  drücken
 - Standardabfolge der Kalibrierung für Pufferlösung mit pH-Wert 7 und 4.

- **Set Point**

- Taste  drücken
 - Die Taste Set gedrückt halten und den Wert über die Tasten  verändern.

- **Sp_7.4ph__**

- Die Tasten   (zusammen) 5 Sekunden lang gedrückt halten, um in das Konfigurationsmenü zu gelangen:

- **Parameter**

-  drücken, um die folgenden Punkte einzustellen

- **Konfig_Pumpe**

- (pH oder Redox wählen)



- **Sprache**

- (Es können 5 Sprachen eingestellt werden EN, IT, SP, DE, FR)



- **Fluss**

- Über die Tasten  auswählen
 - Der Durchflusseingang (Hochspannung), der parallel zur Rückförpumppe angeschlossen ist, kann aktiviert (ON) oder deaktiviert (OFF) werden.



- **Sollwert__7.4ph**

- Über die Taste  auswählen und über  einstellen)
 - Der Wert kann zwischen 0 und 14 pH oder für Redoxmessungen zwischen 0 und +1000 mV verändert werden.



- **Sollwert_Typ__Saure**

- Über die Taste  auswählen und über  einstellen
 - Kann zur Dosierung einer alkalischen oder einer sauren Lösung oder für Redox auf High oder Low gestellt werden.



○ **OFA_Zeit_____off**

- Über die Taste  auswählen und über  einstellen
- Hier kann die OFA-Zeit (Zeit der Überdosierung in Minuten) verändert werden.



○ **Alr Band_____10.0 pH**

- Über die Taste  auswählen und über  einstellen)
- Der Wert kann zwischen 0,4 und 10 pH oder für Redoxmessungen zwischen 40 und 1000 mV verändert werden.

○ **Kalibration_7/4pH**

- Über die Taste  auswählen und über  einstellen
- Die Abfolge der Kalibrierung kann auf 2 Punkte (7 und 4 pH), oder bezugswert oder die Funktion deaktiviert werden; für Redox haben wir 465 mV oder Funktion deaktiviert.

○ **Temperatur_Man_25°C**

- Über die Taste  auswählen und über  einstellen
- Der Temperaturwert kann manuell eingegeben werden (nur bei der pH-Messung)

- Speichern und das Programmmenü über die Taste ESC verlassen.

○ **Verlassen_____Sichern**

- Über die Taste  auswählen und über  einstellen

○ **Ansaugung_____**





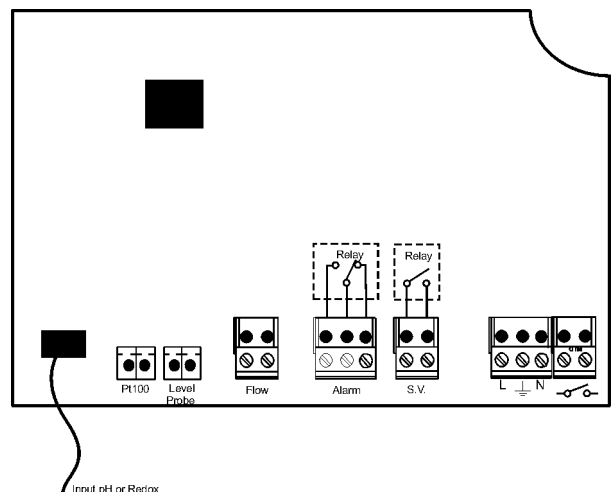

- Für die Funktion manuelles Ansaugen die Taste  3 Sekunden lang gedrückt halten

Anschluss der Kabel

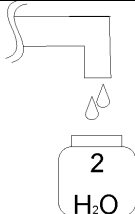
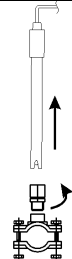
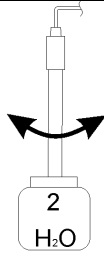
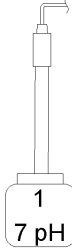
- 1) Eingang pH- oder Redoxfühler
- 2) Eingang Temperaturfühler (PT100)
- 3) Eingang Füllstandssonde (Produkt im Produkttank)
- 4) Durchflusseingang, Durchfluss Rückförpumppe (elektrisches Signal 230 Vac)
- 5) Ausgang Alarmrelais (Kontakt sauber, Relais 250 Vac, 10 A Widerstandsbelastung)
- 6) Ausgang Relais für Elektroventil (Kontakt sauber, Relais 250 Vac, 10 A Widerstandsbelastung)
- 7) Stromversorgung 230 Vac 50 Hz.
- 8) Stromunterbrechungsschalter.

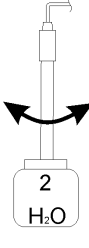
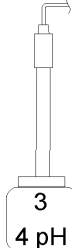

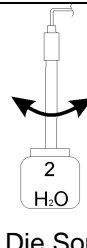



Kalibrierung der pH-Sonde



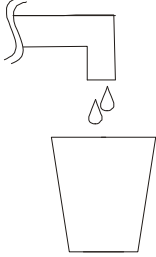
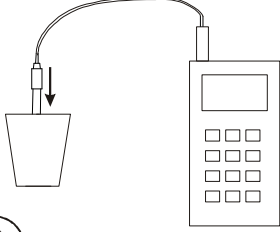

<p>①  2 H₂O</p>	<p>② </p>	<p>③  2 H₂O Die Sonde spülen</p>
<p>④  1 7 pH Die Sonde in die Pufferlösung halten</p>	<p>Kalibration  Die Taste CAL 3 Sekunden lang drücken</p> <p>⑤</p>	<p>7pH_CAL_Drucken  Die Kalibrierung dauert eine Minute 60s_Pause</p> <p>⑥</p>
<p>7pH_Qualitat_100% Qualität der Sonde</p> <p>⑦</p>	<p>⑧  2 H₂O Die Sonde spülen</p>	<p>⑨  3 4 pH Die Sonde in die Pufferlösung halten</p>
<p>4pH_CAL_Drucken  Die Kalibrierung dauert eine Minute 60s_Pause</p> <p>⑩</p>	<p>4pH_Qualitat_100% Qualität der Sonde</p> <p>⑪</p>	<p>⑫  2 H₂O Die Sonde spülen</p>
<p>⑬ </p>	<p> Die Taste CAL drücken, um die Kalibrierung zu verlassen und die Daten zu speichern</p> <p>⑭</p>	<p>⑮ Normaler Mess- und Kontrollstatus</p>

Kalibrierung Bezugswert der pH-Sonde

Bevor fortgefahren wird, muss die Kalibrierung **Bezugswert** aktiviert werden.

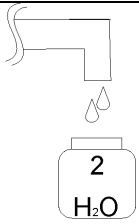
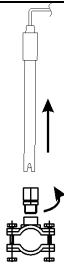
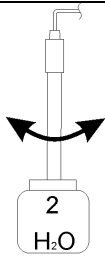
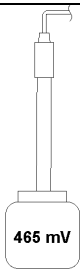
 <p>1 Wasser aus der Anlage zapfen</p>	 <p>2 Mit einem tragbaren Messgerät den pH-Wert des Wassers messen</p>	<h2>Kalibration</h2>  <p>3 Die Taste CAL 3 Sekunden lang drücken</p>
<h2>Bezugswert 7.0 pH</h2>  <p>4 Über die Tasten + und – die Messung des tragbaren Messgeräts eingeben</p>	<h2>Pause</h2>  <p>5 CAL drücken, um die Kalibrierung abzuschließen</p>	

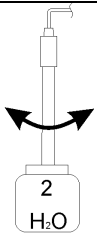
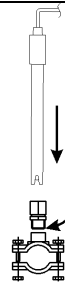
Kalibrierung der Redox-Sonde

<p>①</p> 	<p>②</p> 	<p>③</p>  <p>Die Sonde spülen</p>
<p>④</p>  <p>Die Sonde in die Pufferlösung halten</p>	<p>Kalibration</p>  <p>Die Taste Kal 3 Sekunden lang drücken</p> <p>⑤</p>	<p>465mv_CAL_Drucken</p>  <p>Die Kalibrierung dauert eine Minute</p> <p>60s_Pause</p> <p>⑥</p>
<p>465mv_Qualitat_100%</p> <p>Qualität der Sonde</p> <p>⑦</p>	<p>⑧</p>  <p>Die Sonde spülen</p>	<p>⑨</p> 
<p></p> <p>Die Taste Kal 3 Sekunden lang drücken</p> <p>⑩</p>	<p>Normaler Mess- und Kontrollstatus</p> <p>⑪</p>	

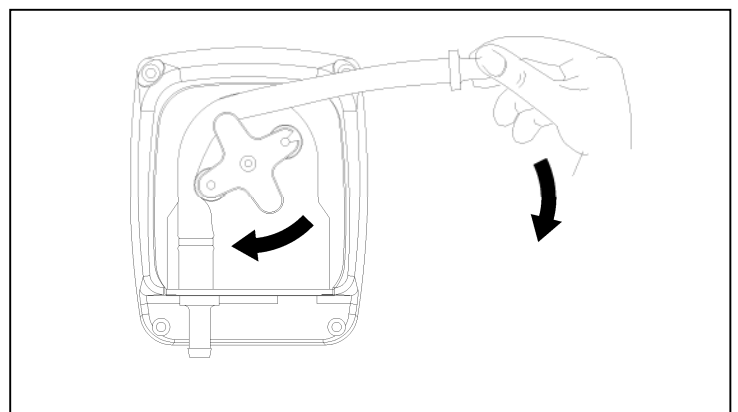
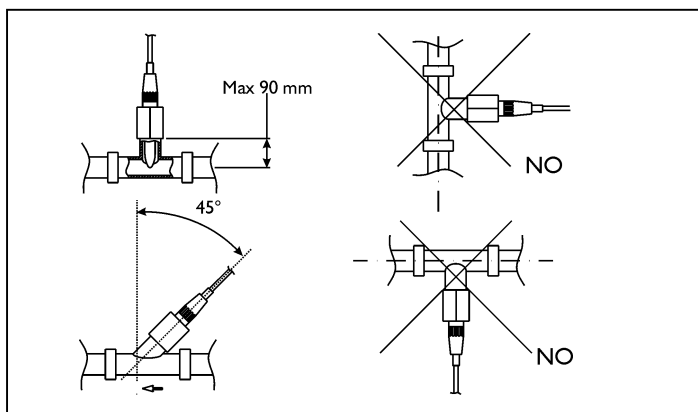
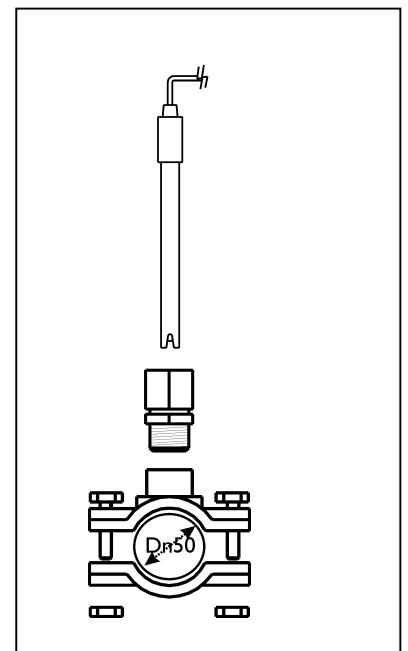
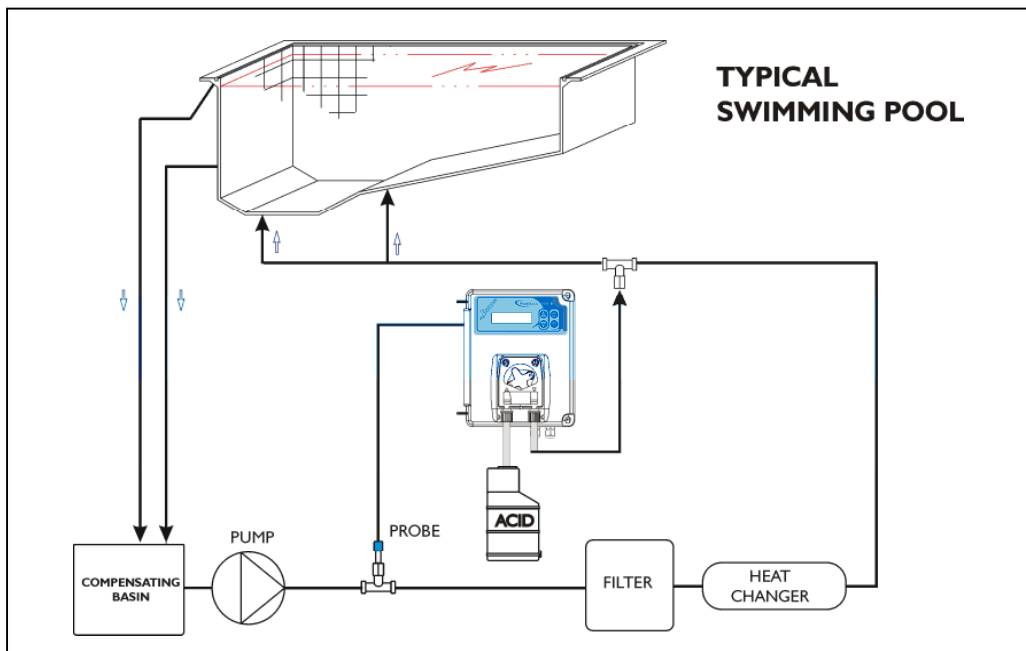

Alarm	Display	Relais	Was ist zu tun
Füllstandsalarm	Fullstand__7,2_ph	Alarm Relais geschlossen	- Die Taste Enter drücken, um den Alarm auszuschalten - Produkt im Produkttank auffüllen
Erster OFA-Alarm (Zeit >70%)	Alarm_OFA_7,2_ph	Alarm Relais geöffnet	- Die Taste Enter drücken, um den Alarm zu beseitigen
Zweiter OFA-Alarm (Zeit=100%)	STOP_OFA_7,2_ph	Alarm Relais geschlossen	- Die Taste Enter drücken, um den Alarm zu beseitigen
Wasserdurchfluss (Rückführungspumpe ausgeschaltet)	Fluss__7,2_ph	Alarm Relais geöffnet	- Wasserrückführungspumpe wieder einschalten.
Systemfehler	Parameter_Error	Alarm Relais geöffnet	- Enter drücken, um die Werkseinstellungen wieder herzustellen - System kaputt
Kalibrierfunktion	Fehler_7_ph Fehler_4_ph Fehler_465_mv	Alarm Relais geöffnet	- Die Sonde oder die Pufferlösung austauschen und die Kalibrierung wiederholen.

- Werkparameter:**
- Sprache = **FR (Französisch)**
 - SetPoint Wert = **7,2 pH; 750mV (Rx)**
 - Dosiermethode = **Säure; Niedrig (Rx)**
 - OFA-Zeit = **OFF**
 - Kalibrierung = **7/4 (2 Punkte); 465mV**
 - Durchflusseingang = **ON**

- Um die Werkseinstellungen (Default) wieder herzustellen, wie folgt vorgehen:**
- Das Basic-System ausschalten
 - Die Taste UP (Aufwärts) und DOWN (Abwärts) gedrückt halten und das Basic-System einschalten.
 - Das System zeigt folgendes an: **Initial Strörung__no**
 - UP (Aufwärts) drücken **Initial Storung__Yes**
 - Die Taste Enter drücken, um die Parameter wieder herzustellen.

LMP

Contenido de la caja

- A) "LMP" pH/Redox sistema de control (modelo estándar)
- B) Tubo de aspiración PVC Cristal 4x6 (4 m)
- C) Tubo de envío polietileno (5 m)
- D) Tornillos con tacos ($\phi = 6$ mm)
- E) Filtro de fondo (PVC)
- F) Válvula de retención en FPM (3/8" GAS)
- G) SPH-1 electrodo pH
- H) PSS3 porta sonda (1/2" GAS)
- I) Soporte de montaje para PSS3 2" pulgadas ($\phi=50$ mm)
- L) pH 4, pH 7, H₂O Kit soluciones tampones
- M) Reducción para la válvula antirretorno

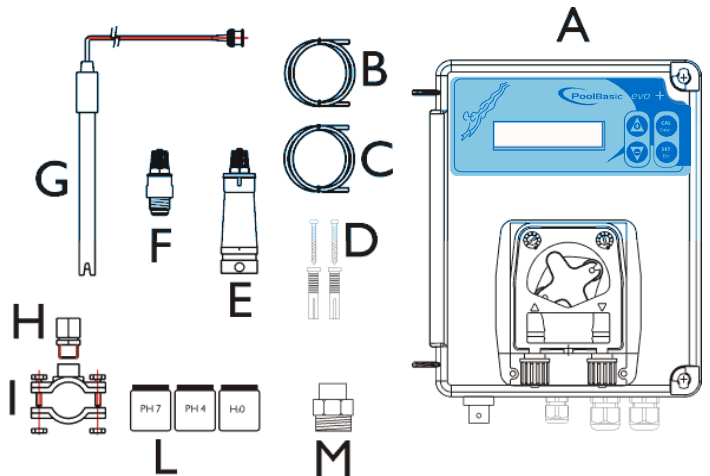

DIMENSIONES

Dimensiones (H – W – L)	234x162x108 mm
Peso	1 Kg.
Alimentación	50 Hz 230 VAC
Consumo	12 W or 18 W
Caudal de la bomba	1,5 l/h
Contrapresion maxima	1,5 bar
Estado de la bomba	Pausa - Alimentación
Rango medida	pH 0 ÷ 14.0; Redox 0÷ +1000 mV
Rango control pH	0.0 pH – 14.0 pH
Precision	+/- 0,2 pH; ± 3 mV
Regulación electrodo	Automatic

MONTAJE PARED

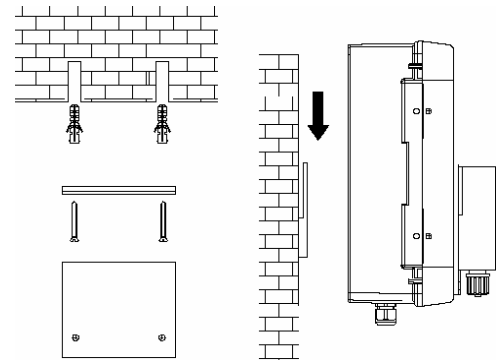

ATENCIÓN / ATTENZIONE / WARNING / ATTENTION / ACHTUNG

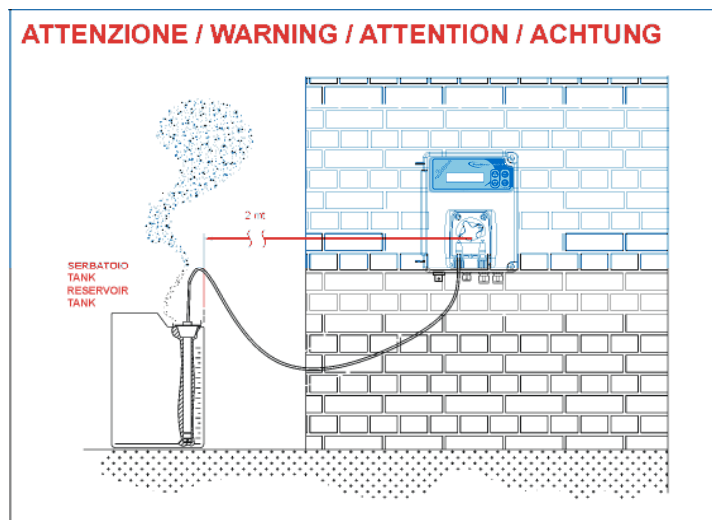



Instrucciones

Funciones:

- **Calibración**

- Presionar pulsador  durante 3 segundos
 - Rutina de calibración estándar para soluciones patrón pH 7 y pH4

- **Set Point ó Valor deseado**

- Presionar pulsador 
 - Mantener pulsado SET y con los pulsadores de subir y bajar  ajustar el valor deseado.

- **Sp_7.4ph_____**

- Configuración de parámetros. Presionar juntos  durante 5 segundos



- **Program_configuration**

- (Presionar  para las siguientes instrucciones)



- **Configuration_pump_____**

- (Ajustar con subir ó bajar  pH o Redox), pulsar  para salir



- **Language_____**

- Con Subir y Bajar  es posible elegir entre 5 idiomas EN, IT, SP, DE, FR
 - (Ajustar con subir ó bajar pH o Redox), pulsar  para salir



- **Flow_____**

- Ajustar el valor con  y con los pulsadores de subir o bajar 
 - Es posible conectar (ON) o desconectar (OFF) la entrada de señal



- **setpoint_____7.4ph**

- Ajustar el valor con  y los pulsadores de subir o bajar 
 - Es posible ajustar desde 0 a 14 el valor de pH y 0 to 1000 mV para Redox



- **sp_type_____acid**

- Ajustar el valor con  y los pulsadores de subir o bajar 
 - Es posible ajustar Acido (pH -) o Alcalino (pH +) y Alto (dosificacion oxidante) o Bajo (dosificacion reductor) para Redox.



○ Time_ofa_____off

- Ajustar el valor con  y los pulsadores de subir o bajar 
- Es posible ajustar el tiempo de OFA en minutos



○ Alr Band___10.0 pH

- Ajustar el valor con  y los pulsadores de subir o bajar 
- Es posible ajustar desde 0,4 a 14 el valor de pH y 40 to 1000 mV para Redox

○ Calib_____7/4pH

- Ajustar el valor con  y los pulsadores de subir o bajar 
- Es posible seleccionar 2 puntos pH7 y pH 4 , con referencia o función desconectada; para Redox solo es posible desconectar la función.

○ Man_Temperature_25*C_

- Ajustar el valor con  y los pulsadores de subir o bajar 
- Esta función solo esta disponible para la medida de pH.
-

- Para salir y escapar del menú de programación pulsar la tecla ESC.

○ Exit_____save

- Ajustar el valor con  y los pulsadores de subir o bajar 

○ Priming





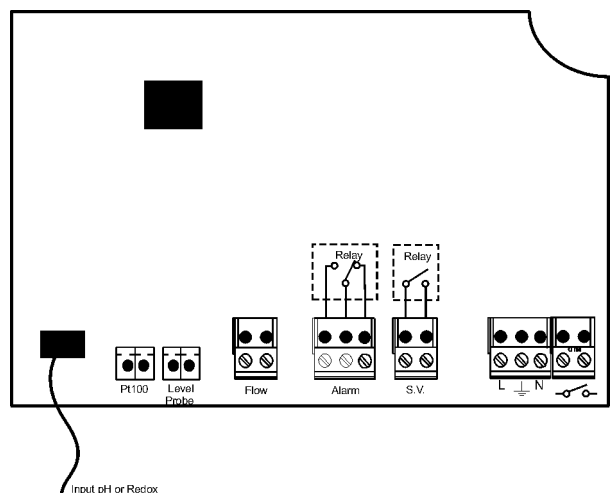

- Para cebar (cargar) la bomba dosificadora presionar el pulsador  durante 3 segundos.

Conexiones

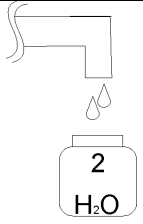
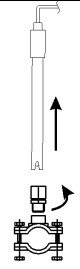
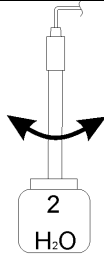
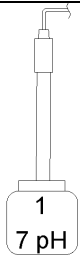
- 1) **Input Probe**, conexión electrodo.
- 2) **Input Temp**, sensor temperatura (PT100) no incluida,
- 3) **Input Level**, control de nivel del tanque de producto químico, no incluido
- 4) **Input Flow**, entrada de control de recirculación (entrada de 230 Vac)
- 5) **Alarm Relay** rele de alarma libre de potencial 250Vac 10 A.
- 6) **S.V. Relay** Rele para control de electro válvula libre de potencial 250Vac 10A
- 7) Alimentación 230 Vac
- 8) Interruptor de paro – marcha.

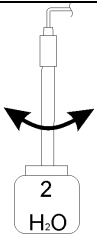
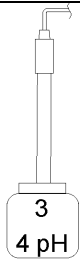

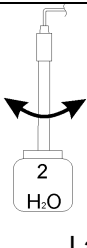



Calibración electrodo de pH



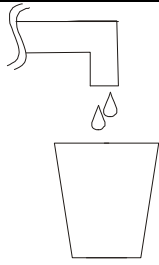
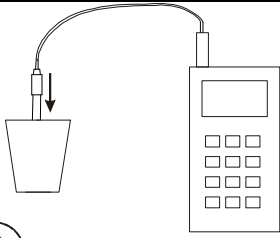

<p>1</p>  <p>2 H₂O</p>	<p>2</p> 	<p>3</p>  <p>2 H₂O</p> <p>Lavar</p>
<p>4</p>  <p>1 7 pH</p> <p>Poner en la solución pH 7</p>	<p>Calibración</p>  <p>Pulsar CAL durante 3 segundos</p> <p>5</p>	<p>Press_cal</p>  <p>Duración de la calibración 1 min.</p> <p>Espera 60s</p> <p>6</p>
<p>pH7_Calidad_100%</p> <p>Calidad electrodo</p> <p>7</p>	<p>8</p>  <p>2 H₂O</p> <p>Lavar</p>	<p>9</p>  <p>3 4 pH</p> <p>Poner en la solución pH 4</p>
<p>pH 4_Press_cal</p>  <p>Duración de la calibración 1 min.</p> <p>Espera 60s</p> <p>10</p>	<p>pH4_Calidad_100%</p> <p>Calidad electrodo</p> <p>11</p>	<p>12</p>  <p>2 H₂O</p> <p>Lavar</p>
<p>13</p> 	<p></p> <p>Presionar ENTER para salvar y salir</p> <p>14</p>	<p>15</p> <p>Estado Normal</p>

Calibración Referencia electrodo de pH

Antes de empezar es necesario habilitar la calibración **Referencia**.

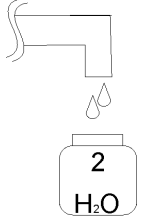
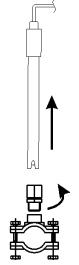
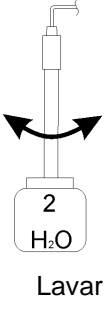
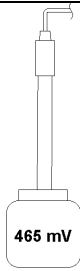
<p>1</p>  <p>Recoger algunas gotas de agua de la instalación</p>	<p>2</p>  <p>Con un instrumento portátil, medir el valor pH del agua</p>	<p>Calibracion</p>  <p>3</p> <p>Pulsar CAL durante 3 segundos</p>
<p>Referencia 7.0 pH</p>  <p>4</p> <p>Con las teclas + y -, introducir la medida leída por el instrumento portátil</p>	<p>Espera</p>  <p>5</p> <p>Pulsar CAL para terminar la calibración</p>	

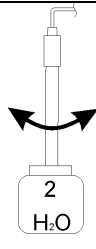
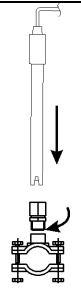
Calibración electrodo de Redox

<p>①</p> 	<p>②</p> 	<p>③</p>  <p>Lavar</p>
<p>④</p>  <p>Keep probe into Buffer solution</p>	<p>Calibración</p>  <p>Pulsar CAL durante 3 segundos</p> <p>⑤</p>	<p>465mv__Press_cal</p>  <p>Duración de la calibración 1 min.</p> <p>Esperar_____60s_____</p> <p>⑥</p>
<p>465mv_Calidad_100%</p> <p>Calidad electrodo</p> <p>⑦</p>	<p>⑧</p> 	<p>⑨</p> 
 <p>Presionar CAL durante 3 segundos</p> <p>⑩</p>	<p>Estado Normal.</p> <p>⑪</p>	

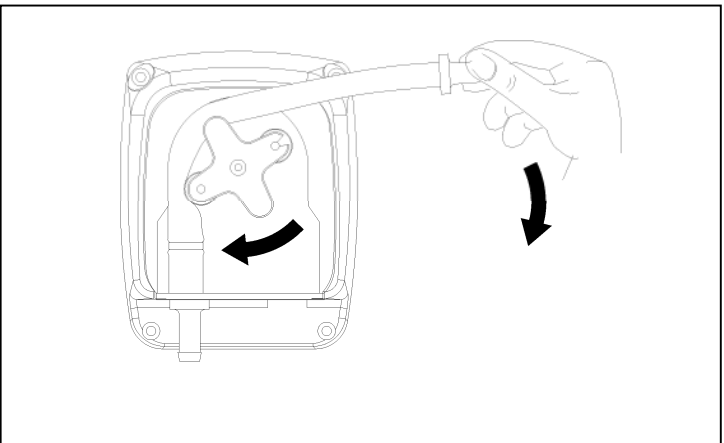
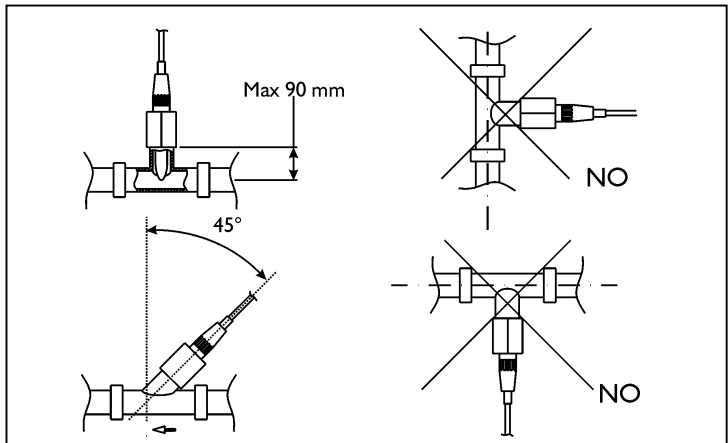
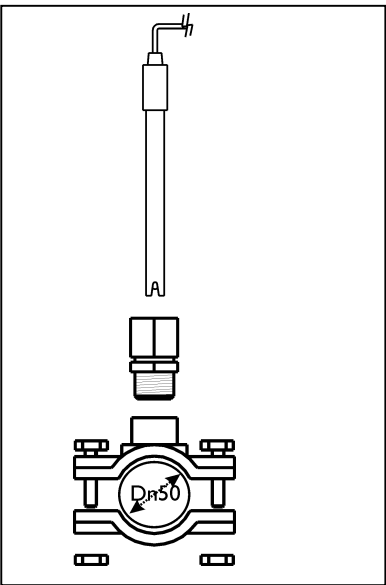
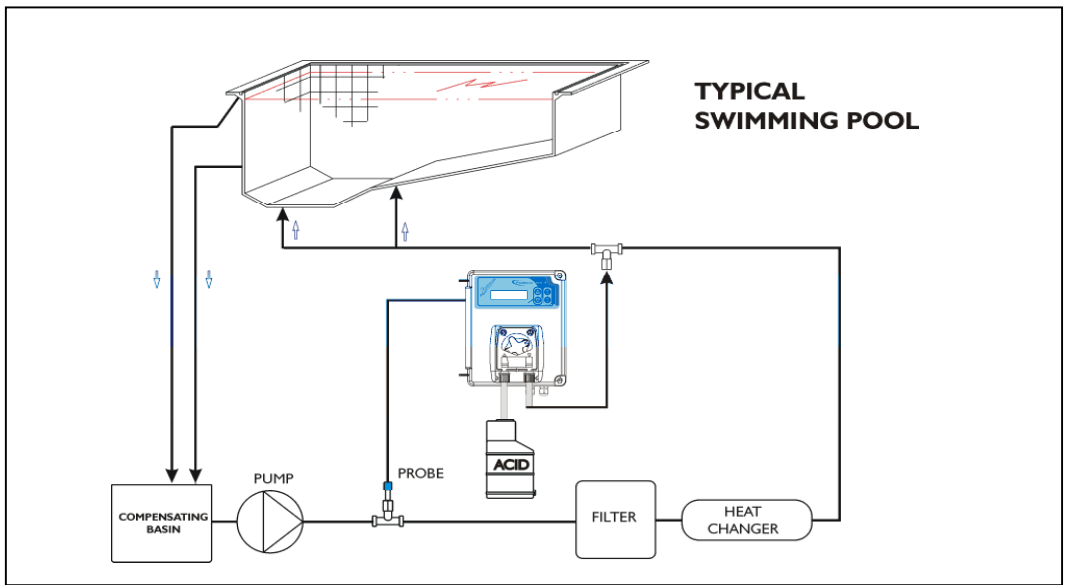

Alarma	Display	Rele	Acciones a hacer
Level	level___7,2_ph	Rele de alarma cerrado	- Pulsar Enter para abrir el rele de alarma. - Rellenar el deposito de producto químico
OFA First Alarm (time >70%)	ofa_alarm__7,2_ph	Rele de alarma abierto	- Pulsar Enter para aceptar.
OFA Second Alarm (time =100%)	ofa_stop__7,2_ph	Rele de alarma cerrado	- Pulsar Enter para acepta
Flow Rate	Flow_____7,2_ph	Rele de alarma abierto	- Restaurar el caudal o recirculación.
System Error	Parameter_error	Rele de alarma abierto.	- Presione Enter para sustituir el valor defectuoso - Equipo averiado. - Posible obstrucción de la inyección
Calibration Funciont	Error_7_ph Error_4_ph	Rele de alarma abierto.	- Sustituir el electrodo o solución patrón y repetir la calibración.

- Parámetros de fabrica:**
- Idioma = **FR (Francés)**
 - Set Point= **7,2 pH**
 - Tipo de dosificación = **Acid**
 - Tiempo OFA = **OFF**
 - Calibración = **7/4 (2 points); 465 mV (Rx)**
 - Entrada de caudal **ON**

- Restaurar valores de fabrica:**
- Desconectar la unidad electricamente
 - Manteniendo pulsado subir y bajar dar corriente a la unidad.
 - En el display parpadea **Init.default__no**
 - Presionar el pulsador subir
 - **Init.default__Yes**
 - Presionar el pulsador Enter para restaurar los valores de fabrica..

LMP

Contenu de l'emballage

- A) Régulateur pH/Redox "LMP"
- B) Tube d'aspiration PVC Cristal Ø 4x6 (4 m)
- C) Tube de refoulement PE Ø 4x6 (5 m)
- D) Kit étrier de fixation
- E) Crépine (PVC)
- F) Clapet d'injection (3/8" GAS)
- G) Electrode pH SPH-1
- H) Porte sonde PSS3 (1/2" GAS)
- I) Collier de prise en charge pour porte sonde et clapet d'injection (φ=50 mm)
- L) Kit solution tampon pH 4, pH 7, H₂O
- M) Réduction pour clapet d'injection

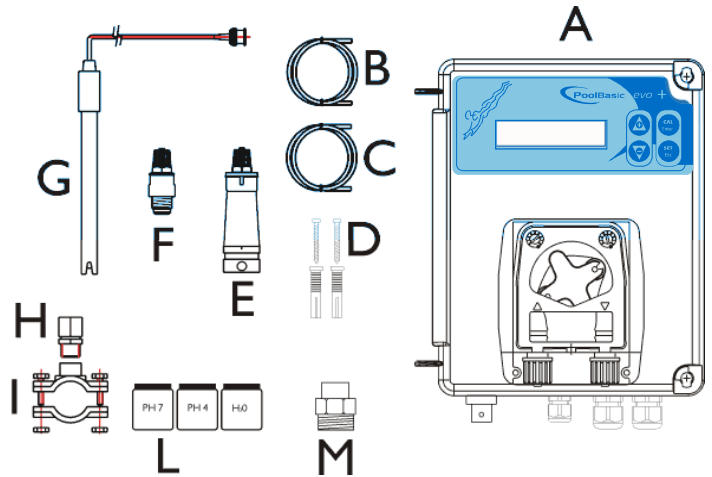

SPÉCIFICATIONS TECHNIQUES

Dimensions (H – L – P)	234x162x108 mm
Poids	1 kg
Alimentation	230 VC.A.
Consommation	12 W ou 18 W
Débit de la pompe	1,5 l/h
Contre-pression maximale	1,5 bar
État de la pompe	Pause - Activation
Échelle de mesure	pH 0 ÷ 14,0 Redox 0 ÷ +1000 mV
Précision de la mesure	± 0,1 pH; ±10 mV
Précision	± 0,02 pH; ±2 mV
Étalonnage de l'électrode	Automatique

Fixation murale

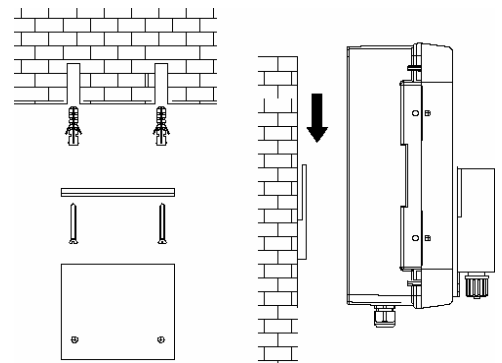

ATTENZIONE / WARNING / ATTENTION / ACHTUNG

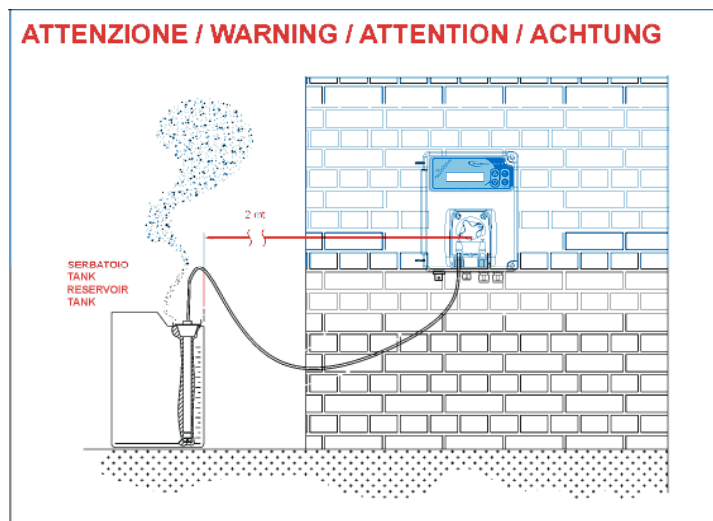

Réglages

Fonction :



- **Étalonnage**

- Appuyer sur la touche  pendant 3 secondes
 - Séquence Standard étalonnage pour la solution tampon 7 et 4 pH.

- **Set Point ou point de consigne**

- appuyer sur la touche 
 - Maintenir la touche SET appuyée et modifier la valeur par les flèches

- **Sp_7.4ph**

- Appuyer sur les touches   Setup (en même temps) pendant 5 secondes pour activer le menu configuration:

- **Paramètres**

- Appuyer sur  pour programmer les paramètres ci-après

- **Config_Pompe**

- (Sélectionner  pH ou Rédox)



- **Langue**

- (On peut régler 5 différentes langues EN, IT, SP, DE, FR)



- **Débit**

- (Appuyer sur les flèches Haut et Bas)
- On peut activer (ON) ou désactiver (OFF) l'entrée Flux (tension 230 V) connectée en parallèle à la pompe de circulation



- **Consigne_____7.4ph**

- Sélectionner avec la touche  et programmer avec flèche 
- On peut modifier la valeur de 0 à 14 pH ou de 0 à +1000 mV pour la mesure du potentiel Rédox.

- **Produit_Dose__Acide**

- Sélectionner avec la touche  et programmer avec flèche 
- On peut le modifier pour dosages Acides ou Alcalins ou High (haut) ou Low (bas) pour le potentiel Rédox.

○ Temps_OFA_____off



- Sélectionner avec la touche  et programmer avec flèche 
- On peut modifier le temps OFA (minutes), temps de surdosage

○ Alr Band___10.0 pH

- Sélectionner avec la touche  et programmer avec flèche 

On peut modifier la valeur de 0,4 à 14 pH ou de 40 à 1000 mV pour la mesure du potentiel Rédox.

○ Calibrage__7/4pH

- (Sélectionner avec la touche  et programmer avec flèche 
- On peut modifier la séquence de calibrage pour 2 points (7 et 4 pH), avec référence ou désactiver la fonction ; pour la mesure du potentiel Rédox, le choix est entre 465 mV et fonction désactivée.

○ Correction_Temp_25°C

- Sélectionner avec la touche  et programmer avec flèche 
- On peut programmer la valeur de température manuelle (uniquement pour la mesure du pH).

- Enregistrer puis quitter le menu Programme avec la touche ESC.

○ Exit_Sauvegarder

- Sélectionner avec la touche  et programmer avec flèche 

○ Amorcage





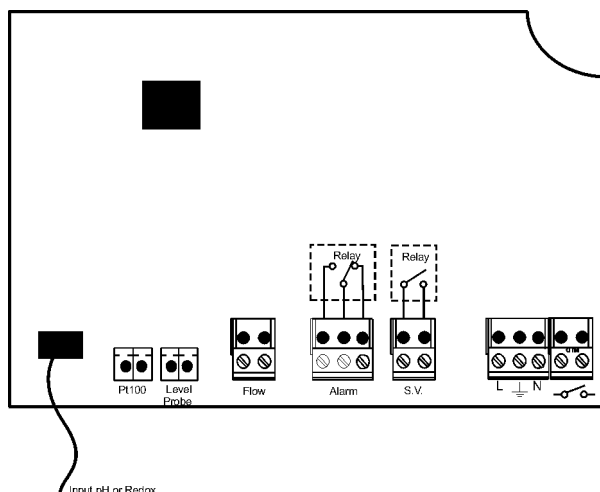

- Pour la Fonction amorçage en manuel, maintenir la touche flèche  appuyée pendant 3 secondes

Connexion des câbles

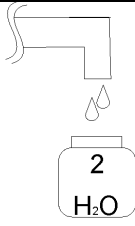
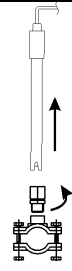
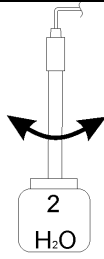
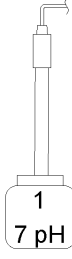
- 1) Entrée sonde pH ou Redox
- 2) Entrée Sonde Température (PT100)
- 3) Entrée sonde de niveau (Produit dans le Bidon)
- 4) Entrée Flow, débit pompe de recirculation (signal électrique 230 Vc.a.)
- 5) Sortie Relais Alarme à distance (Contact libre, Relais 250 Vc.a. 10 A résistif)
- 6) Sortie Relais Alarme pour électrovanne (Contact libre, Relais 250 Vc.a. 10 A résistif)
- 7) Alimentation 230 Vc.a. 50 Hz.
- 8) Interrupteur d'alimentation

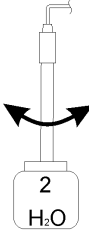
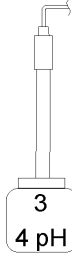

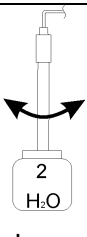



Calibrage Sonde pH



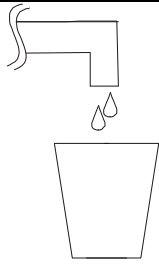
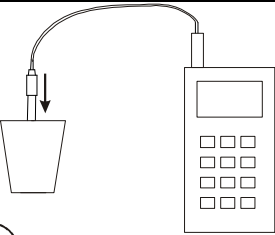

<p>①</p>  <p>2 H₂O</p>	<p>②</p> 	<p>③</p>  <p>Laver la sonde</p>
<p>④</p>  <p>1 7 pH</p> <p>Maintenir la sonde dans la solution tampon</p>	<p>Calibrage</p>  <p>Appuyer sur la touche CAL pendant 3 secondes:</p> <p>⑤</p>	<p>7pH_Presser_CAL</p>  <p>Le calibrage dure une minute. Patienter ___ 60s</p> <p>⑥</p>
<p>7pH_Qualite'_100%</p> <p>Qualité de la sonde</p> <p>⑦</p>	<p>⑧</p>  <p>Laver la sonde</p>	<p>⑨</p>  <p>Maintenir la sonde dans la solution tampon</p>
<p>4pH_Presser_CAL</p>  <p>Le calibrage dure une minute. Patienter ___ 60s</p> <p>⑩</p>	<p>4pH_Qualite'_100%</p> <p>Qualité de la sonde</p> <p>⑪</p>	<p>⑫</p>  <p>Laver la sonde</p>
<p>⑬</p> 	<p></p> <p>Appuyer sur la touche CAL pour quitter et enregistrer les données</p> <p>⑭</p>	<p>⑮</p> <p>État Normal de mesure et contrôle</p>

Calibrage Référence sonde pH

Avant de procéder, il faut activer le calibrage **Référence**.

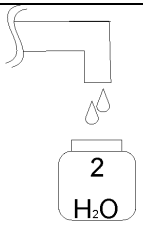
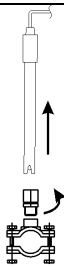
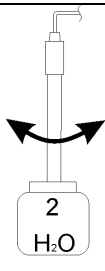
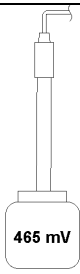
<p>1</p>  <p>Prélever de l'eau de l'installation</p>	<p>2</p>  <p>Avec un instrument portable, mesurer la valeur du pH de l'eau</p>	<p>Calibrage</p>  <p>3</p> <p>Appuyer sur la touche CAL pendant 3 secondes</p>
<p>Reference 7.0 pH</p>  <p>4</p> <p>Avec les touches + et –, saisir la mesure lue par l'instrument portable</p>	<p>Patienter</p>  <p>5</p> <p>Appuyer sur CAL pour terminer le calibrage</p>	

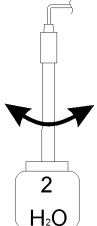
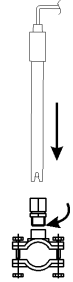
Calibrage sonde Redox

<p>①</p> 	<p>②</p> 	<p>③</p>  <p>Laver la sonde</p>
<p>④</p>  <p>Maintenir la sonde dans la solution tampon</p>	<p>Calibrage</p>  <p>Appuyer sur la touche Cal pendant 3 secondes</p> <p>⑤</p>	<p>465mv_Presser_CAL</p>  <p>Le calibrage dure une minute.</p> <p>Patienter ___ 60s</p> <p>⑥</p>
<p>465mv_Qualite'_100%</p> <p>Qualité de la sonde</p> <p>⑦</p>	<p>⑧</p>  <p>Laver la sonde</p>	<p>⑨</p> 
 <p>Appuyer sur la touche Cal pendant 3 secondes</p> <p>⑩</p>	<p>⑪</p> <p>État normal de mesure et de contrôle</p>	

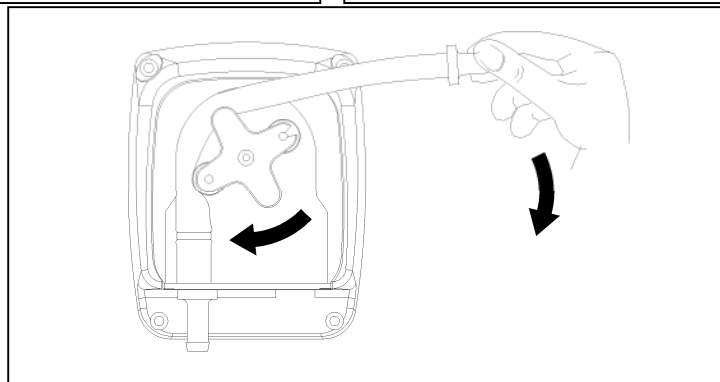
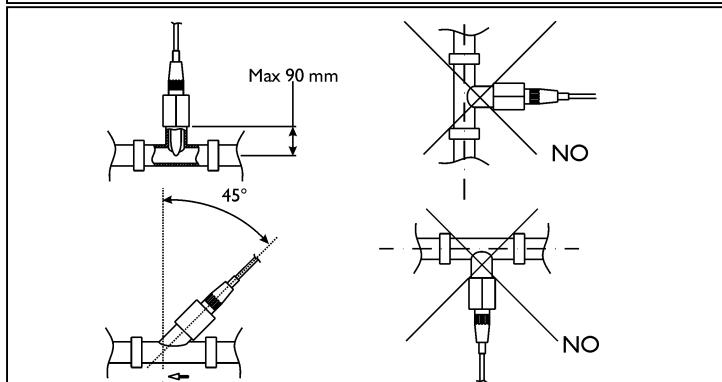
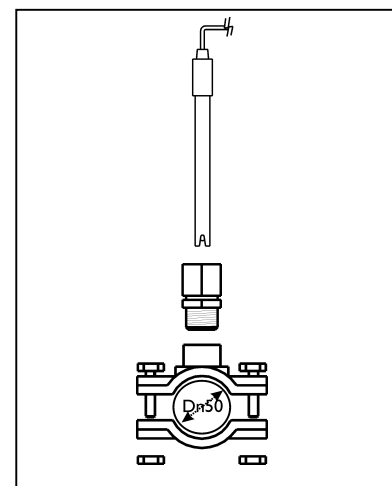
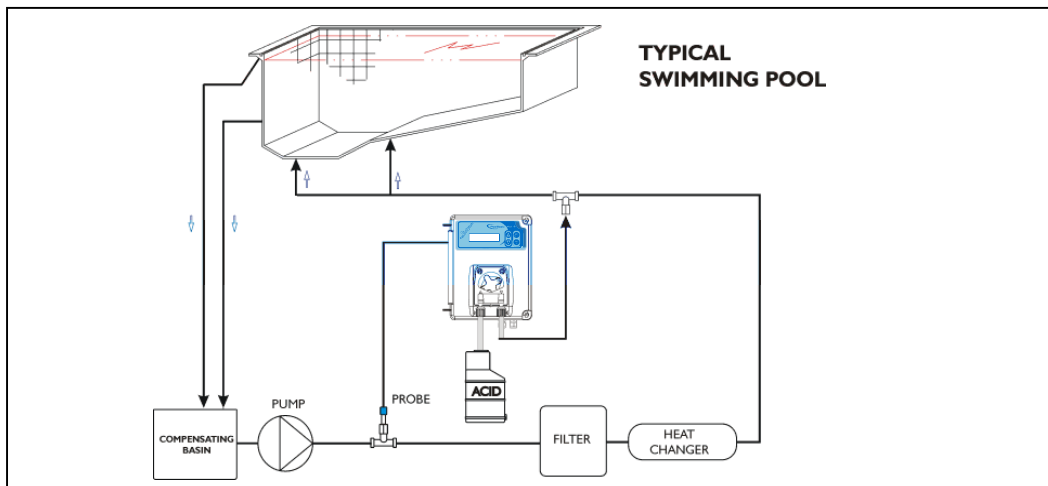

Alarme	Écran	Relais	Actions à exécuter
Niveau	Niveau__7,2_ph	Alarme relais fermé	- Appuyer sur la touche Enter pour désactiver l'alarme à distance - Rétablir le niveau de produit dans le bidon
OFA Première Alarme (Temps >70%)	Alarme_OFA_7,2_ph	Alarme relais ouvert	- Appuyer sur la touche Enter pour désactiver l'alarme
OFA Deuxième Alarme (Temps=100%)	STOP_OFA__7,2_ph	Alarme relais fermé	- Appuyer sur la touche Enter pour désactiver l'alarme
Débit eau (pompe de recirculation éteinte)	Debit_____7,2_ph	Alarme relais ouvert	- Réactiver la pompe de circulation eau.
Erreur de système	Parameter_Error	Alarme relais ouvert	- Appuyer sur Enter pour restaurer les paramètres par défaut - Système endommagé
Fonction d'étalonnage	Erreur_7_ph Erreur_4_ph Erreur_465_mV	Alarme relais ouvert	- Remplacer la Sonde ou la Solution tampon et répéter le calibrage.

- Paramètres d'usine :**
- Langue = FR (Français)
 - Set Point = 7,2 pH; 750mV (Rx)
 - Méthode de dosage = Acide; Basse (Rx)
 - Temps OFA (alarme de surcharge) = OFF
 - Calibrage = 7/4 (2 points) ; 465mV (Rx)
 - Entrée Flux = ON

- Pour restaurer les paramètres par défaut, agir de la façon suivante:**
- Arrêter le système Basic
 - Activer le système Basic en maintenant les touches flèche HAUT (UP) et flèche BAS (DOWN) appuyées.
 - Le Système affiche **Init.default__no**
 - Appuyer sur flèche HAUT (UP)
Init.default__Yes
 - Appuyer sur la touche Enter pour restaurer les paramètres.

LMP

Contenuto nella Scatola

- A) "LMP" pH/Redox sistema di controllo (modello standard)
- B) PVC Cristal 4x6 tubo di aspirazione (4 m)
- C) Polyethylene tubo di mandata (5 m)
- D) Tasselli a vite ($\phi=6$ mm)
- E) Filtro di fondo (PVC)
- F) FPM valvola di non ritorno (3/8" GAS)
- G) SPH-1 elettrodo pH
- H) PSS3 porta sonda (1/2" GAS)
- I) Staffa di montaggio per PSS3 2" pollici ($\phi=50$ mm)
- L) pH 4, pH 7, H₂O Kit soluzioni tampone
- M) Riduzione per valvola di non ritorno

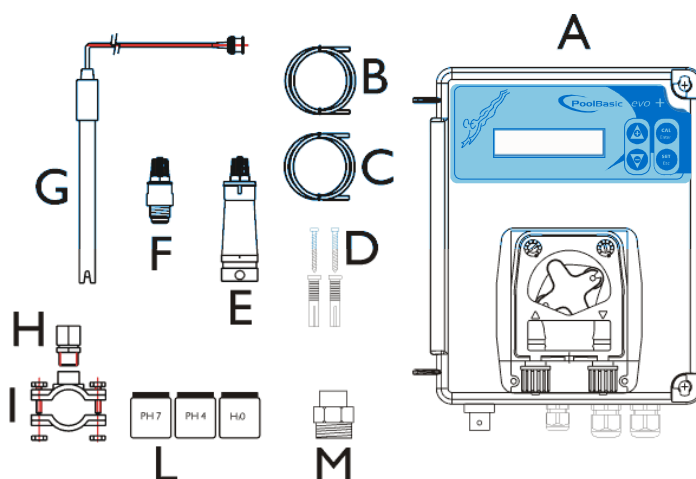

TECHNICAL SPECIFICATIONS

Dimensioni (A – L – P)	234x162x108 mm
Peso	1 kg
Alimentazione	230 VAC
Consumo	12 W or 18 W
Portata Pompa	1,5 l/h
Contro pressione Massima	1,5 bar
Stato pompa	Pausa - Lavoro
Scala Misura	pH 0 ÷ 14.0; Redox 0 ÷ +1000 mV
Precisione Misura	± 0,1 pH; ±10 mV
Accuratezza Misura	± 0,02 pH; ±2 mV
Calibrazione Elettrodo	Automatica

Montaggio Parete

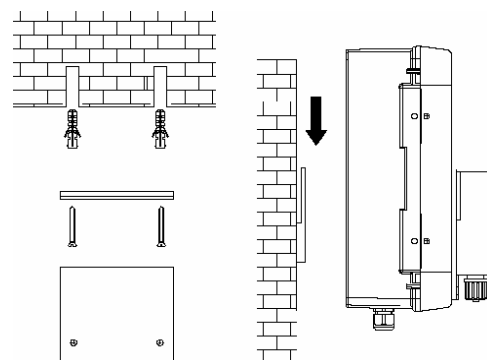

ATTENZIONE / WARNING / ATTENTION / ACHTUNG

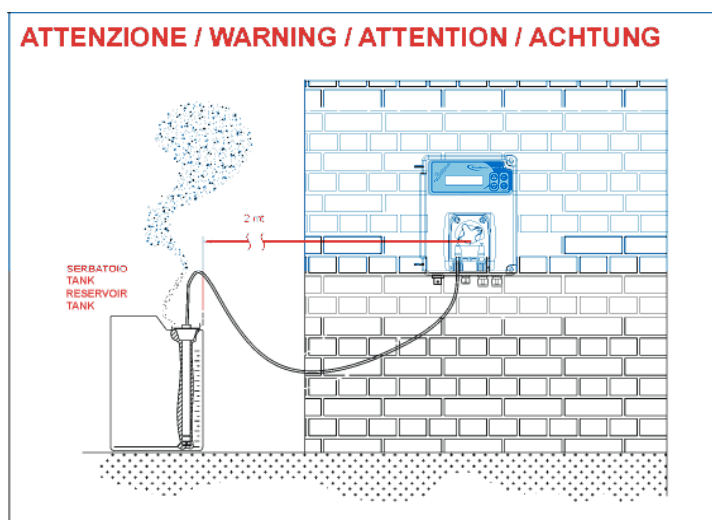



Impostazioni

Funzione:

- **Calibrazione**

- (Premere tasto  per 3 Secondi):
 - Sequenza Standard calibrazione per soluzione tampone 7 and 4 pH.

- **Set Point**

- Premere tasto: 
- Tenere premuto SET e modificare valore con tasto 
- **Sp_7.4ph**

- Premere tasti  (insieme) per 5 Secondi e si eseguirà il menu configurazione:

- **MENU CONFIGURAZIONE**

- (Premere  impostare le seguenti voci)

- **CONFIGURAZIONE POMPA**

- (Selezionare  pH o Redox)



- **LINGUA**

- (Con il pulsante  si può impostare 5 lingue EN, IT, SP, DE, FR)



- **FLUSSO**



- Selezionare con il tasto 
- Si può abilitare(ON) or disabilitare (OFF) l'ingresso Flusso (alta tensione) collegato in parallelo alla pompa di ricircolo



- **Setpoint_7.4ph**



- Selezionare con il tasto  e impostare con 
- Si può modificare il valore da 0 a 14 pH oppure da 0 a +1000 mV per misura Redox.





- **Tipo_Setpoint_Acido**

- Selezionare con il tasto  e impostare con 
- Si può modificare per dosaggi Acidi o Alcalini oppure High or Low per Redox.

- **Tempo_OFA___off**
 - Selezionare con il tasto  e impostare con 
 - Si può modificare il tempo (minuti) di OFA tempo di savra dosaggio

- **Banda di Allarme__10.0 pH**
 - Selezionare con il tasto  e impostare con 
 - Si può modificare il valore da 0,4 a 10 pH oppure da 40 a 1000 mV per misura Redox.

- **Calibrazione__7/4pH**
 - Selezionare con il tasto  e impostare con 
 - Si può modificare la sequenza di calibrazione per 2 punti (7 e 4 pH), con riferimento oppure funzione disabilitata; per il Redox abbiamo 465 mV o funzione disabilitata.





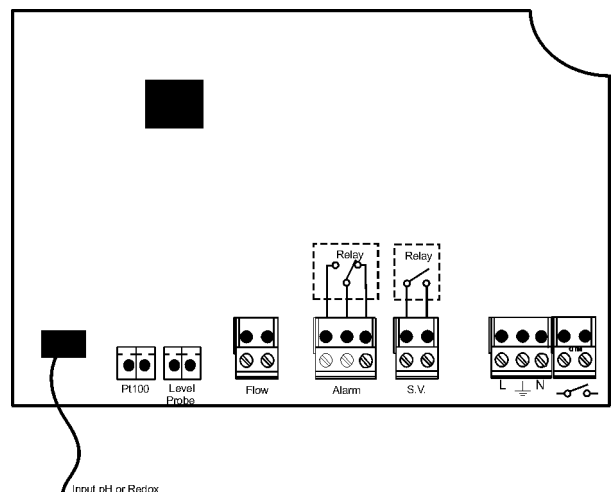

- **Temperatura_Man_25°C**
 - Selezionare con il tasto  e impostare con 
 - Si impostare il valore di temperatura manuale (Solo per la misura del pH)
- Salvare ed uscire dal menù Programma con il tasto ESC.
- **Uscita__Salva**
 - Selezionare con il tasto  e impostare con 
- **Adescamento**
 - Funzione adescamento manuale tenere premuto il tasto  (UP) per 3 secondi

Connessione Cavi

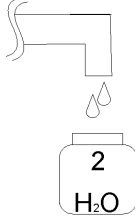
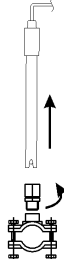
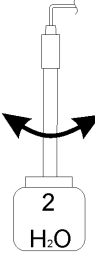
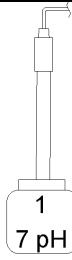
- 1) Ingresso sonda pH or Redox (
- 2) Ingresso sonda Temperature (PT100)
- 3) Ingresso sonda Livello (Prodotto nel Bidone)
- 4) Ingresso Flow, flusso pompa di ricircolo (segnale elettrico 230 Vac)
- 5) Uscita Relè Allarme remoto (Contatto pulito, Relè 250 Vac 10 A Resistivo)
- 6) Uscita Relè per Elettrovalvola (Contatto pulito, Relè 250 Vac 10 A Resistivo)
- 7) Alimentazione 230 Vac 50Hz.
- 8) Interruttore di alimentazione.

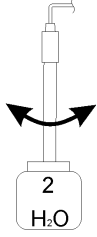
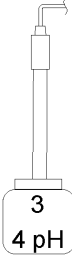

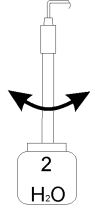
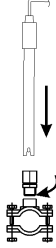



Calibrazione Sonda pH



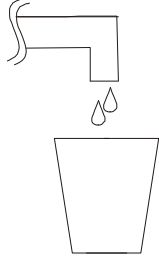
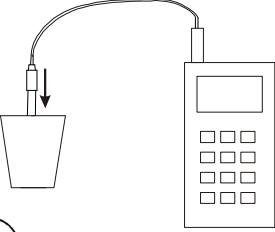

<p>①</p> 	<p>②</p> 	<p>③</p>  <p>Lavare la sonda</p>
<p>④</p>  <p>Mantenere la sonda nella soluzione tampone</p>	<p>Calibrazione</p>  <p>Premere tasto CAL per 3 Secondi</p> <p>⑤</p>	<p>7pH___Premere_CAL</p>  <p>La calibrazione dura un minuto</p> <p>Attendere___60s</p> <p>⑥</p>
<p>7pH_Qualita'_100%</p> <p>Qualità sonda</p> <p>⑦</p>	<p>⑧</p>  <p>Lavare la sonda</p>	<p>⑨</p>  <p>Mantenere la sonda nella soluzione tampone</p>
<p>4pH___Premere_CAL</p>  <p>La calibrazione dura un minuto</p> <p>Attendere___60s</p> <p>⑩</p>	<p>4pH_Qualita'_100%</p> <p>Qualità sonda</p> <p>⑪</p>	<p>⑫</p>  <p>Lavare la sonda</p>
<p>⑬</p> 	<p>⑭</p>  <p>Premere il tasto CAL per uscire e salvare i dati</p>	<p>⑮</p> <p>Stato Normale di misura e controllo</p>

Calibrazione riferimento sonda pH

Prima di procedere bisogna abilitare la calibrazione **Riferimento**.

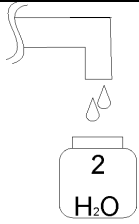
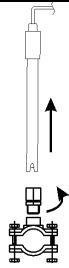
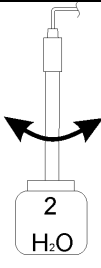
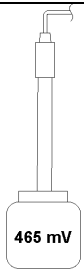
<p>①</p>  <p>Spillare l'acqua dall'impianto</p>	<p>②</p>  <p>Con uno strumento portatile misurare il valore pH dell'acqua</p>	<p>Calibrazione</p>  <p>③</p> <p>Premere tasto CAL per 3 Secondi</p>
<p>Riferimento 7.0 pH</p>  <p>④</p> <p>Con i tasti + e - inserire la misura letta dallo strumento portatile</p>	<p>Attendere</p>  <p>⑤</p> <p>Premere ENTER per terminare la calibrazione</p>	

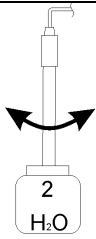
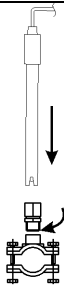
Calibrazione sonda Redox

<p>①</p> 	<p>②</p> 	<p>③</p>  <p>Lavare la sonda</p>
<p>④</p>  <p>Mantenere la sonda nella soluzione tampone</p>	<p>Calibrazione</p>  <p>Premere il tasto Cal 3 Secondi</p> <p>⑤</p>	<p>465mv__Premere_CAL</p>  <p>La calibrazione dura un minuto</p> <p>Attendere__60s</p> <p>⑥</p>
<p>465mv_Qualita'_100%</p> <p>Qualità Sonda</p> <p>⑦</p>	<p>⑧</p>  <p>Lavare la sonda</p>	<p>⑨</p> 
 <p>Premere il tasto Cal 3 Secondi</p> <p>⑩</p>	<p>Normale Stato di misura e controllo</p> <p>⑪</p>	

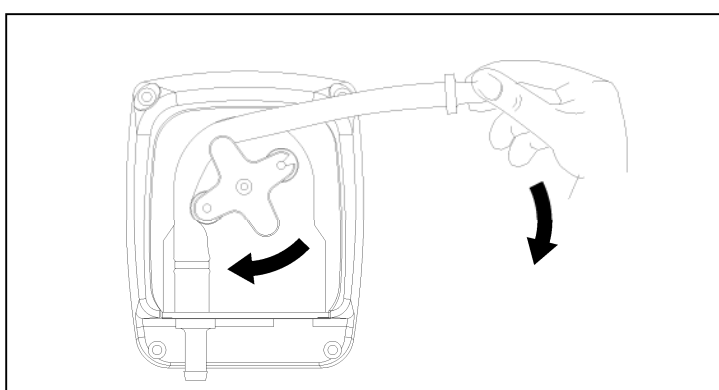
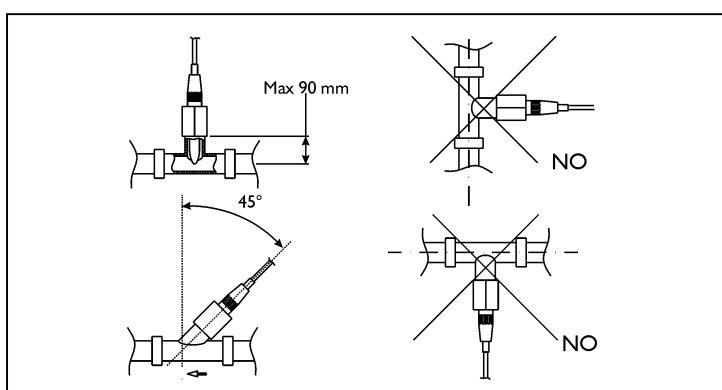
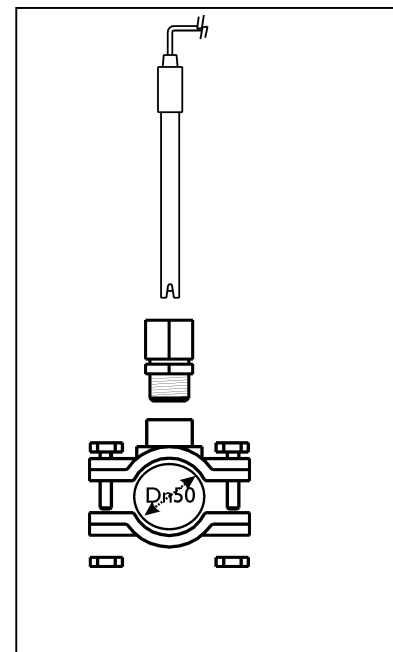
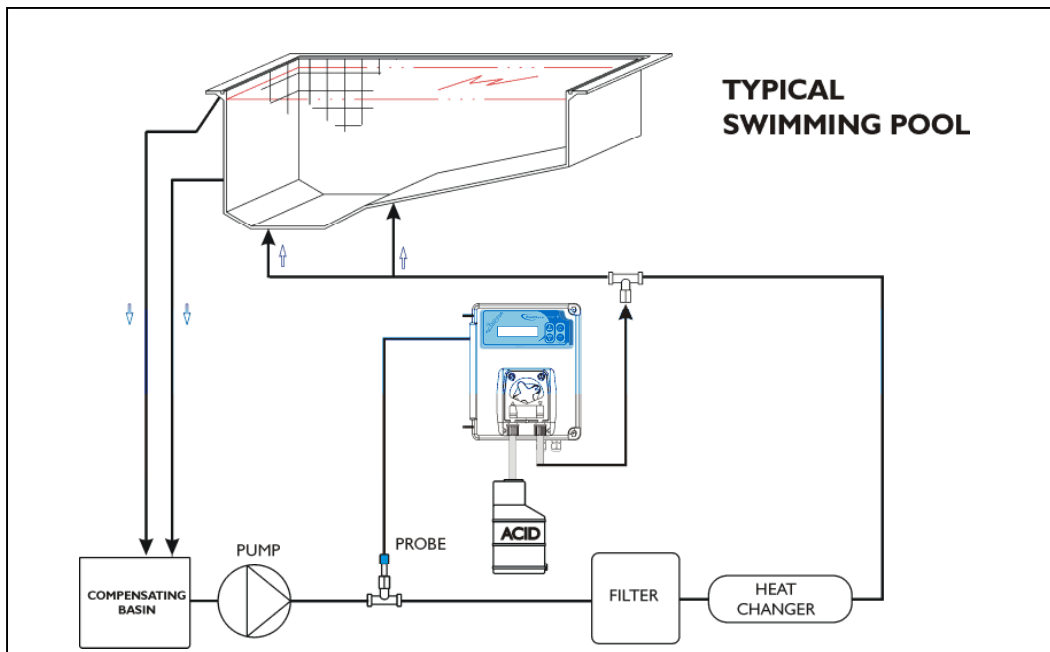

Allarme	Display	Relè	Azioni da fare
Livello	Livello _____ 7,2_ph	Allarme Relè Chiuso	- Premere il tasto Enter per spegnere l'allarme remoto - Ripristinare prodotto nel bidone
OFA Primo Allarme (Tempo >70%)	Allarme_OFA_7,2_ph	Allarme Relè Aperto	- Premere il tasto Enter per eliminare l'allarme
OFA Secondo Allarme (Tempo=100%)	STOP_OFA_7,2_ph	Allarme Relè Chiuso	- Premere il tasto Enter per eliminare l'allarme
Flusso acqua (Pompa di ricircolo spenta)	Flusso _____ 7,2_ph	Allarme Relè Aperto	- Ripristinare pompa di ricircolo acqua.
Errore di Sistema	Parameter_Error	Allarme Relè Aperto	- Premere Enter per ripristinare i parametri di fabbrica - Sistema Rotto
Funzione di Calibrazione	Errore_7_ph Errore_4_ph Errore_465_mV	Allarme Relè Aperto	- Sostituire Sonda o Soluzione tampone e ripetere la calibrazione.

Parametri di Fabbrica:

- Lingua = **FR (Francese)**
- Set Point valore = **7,2 pH; 750mV (Rx)**
- Metodo di Dosaggio = **Acido; Basso (Rx)**
- Tempo OFA = **OFF**
- Calibrazione = **7/4 (2 punti); 465mV (Rx)**
- Ingresso Flusso = **ON**

Per ripristinare I parametri di fabbrica (Default) eseguire i seguenti passi:

- Spegner il sistema Basic
- Mantenere premuto il tasto UP (su) e DOWN (giù) accendere il sistema Basic .
- Il Sistema visualizzerà **Init.default__no**
- Premere UP (su) **Init.default__Yes**
- Premere il tasto Enter per ripristinare i parametri.